

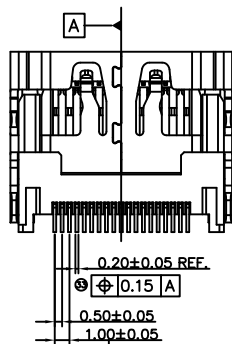

RECOMMENDED PCB LAYOUT
TOL: ±0.05

NOTES:

1. MATERIALS:
HOUSING: THERM-PLASTIC+30%GLASS FILLED, BLACK, UL94V-0
CONTACTS: COPPER ALLOY
SHELL: COPPER ALLOY
2. PLATING:
SHELL: NICKEL PLATING OVERALL.
CONTACT: GOLD PLATING OVER NICKEL IN CONTACT, NICKEL PLATING OVERALL
3. RoHS COMPLIANT
4. DIMENSIONS MARKED ⊕ SHOULD BE MEASURED BY FAI.
5. DIMENSIONS MARKED ▼ MUST BE CONTROLLED IN QIP.

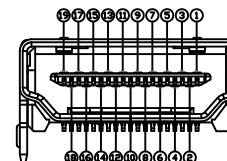
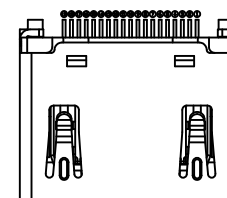
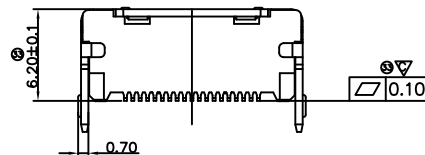
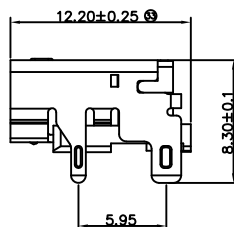
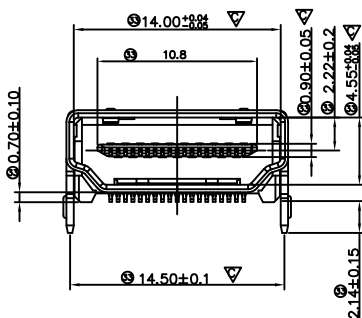

NO 번호	DATE 변경일자	DESCRIPTION OF REVISION 변경내용	DESIGNED 작성	CHECKED 검토	APPROVED 승인	MATERIAL 재질		SPECIFICATION 규격		FINISH 표면처리	QUANTITY 수량	SCALE 척도 UNIT 단위	
						DESIGNED 작성	CHECKED 검토	APPROVAL 승인	DRAWING NUMBER 도번				
			김도현	박재규	최국호	PART NAME 부품명	HY-05H9	 한유안 ELECTRONICS CO.,LTD					
						MODEL NAME 제품명	HY-05H9						
DESIGNED 작성						상현전자 주식회사		3RD ANGLE PROJ	HANYONES TECH CO.,LTD		FILE NO.		