

SPECIFICATIONS:

- ELECTRICAL CHARACTERISTICS:
 - 1-1. RATING: 1.8A (PIN1/5), 0.5A (PIN2/3/4)
 - 1-2. CONTACT RESISTANCE: 30mΩ MAX.(INITIAL)
 - 1-3. DIELECTRIC WITHSTANDING VOLTAGE: 300V AC FOR ONE MINUTE.
 - 1-4. INSULATION RESISTANCE: 100MΩ MIN. MEASURED BY 500 VDC
- MECHANICAL CHARACTERISTICS:
 - 2-1. INSERTION FORCE : 3.6 KGF (MAX)
 - 2-2. WITHDRAWAL FORCE : 0.8 KGF(Reference)
- DURABILITY: 10,000 CYCLES .
- WATER PROOFNESS:THIS PRODUCT IS BASED ON IPX7(1m,30min)
- PLUG INTERFACE DIMENSIONS COMFORM TO USB2.0 SPEC.
- OVAL RING
 - 6-1. The amount of low molecular siloxanes(D3~D10)is less than 200ppm
 - 6-2. Hardness of silicone rubber:70°
- FOR REFLOW SOLDERING LEAD-FREE PROCESS.
- PACKAGING: TAPE & REEL.

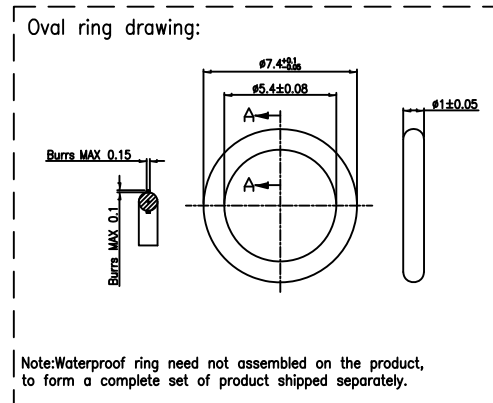

Note:Waterproof ring need not assembled on the product, to form a complete set of product shipped separately.

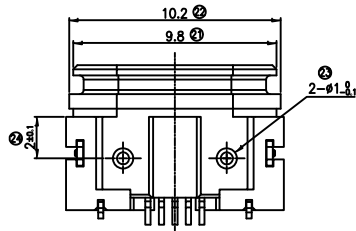
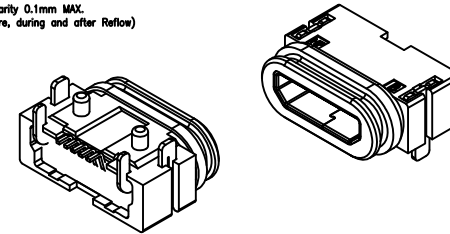
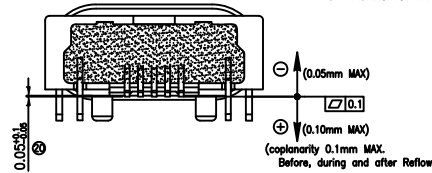
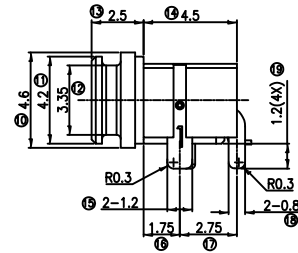
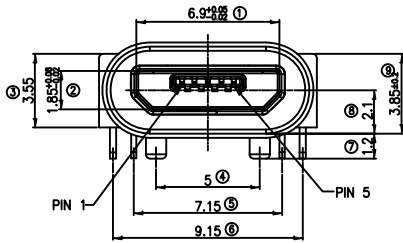
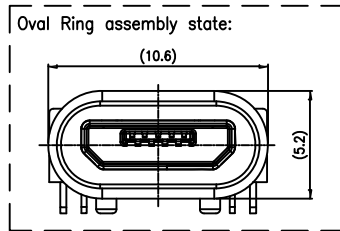

UNLESS OTHERWISE SPECIFIED, TOLERANCE ON DECIMAL:±0.3

ITEM	PAPT NAME	QTY	MATERIAL	FINISHING
④	Contact	5	C18140H T=0.20	
③	Shell	1	SUS304 T=0.25	Nickel
②	Terminal	2	C2680 T=0.3	
①	Housing	1	HI-TEMP.PLASIC UL 94V-0	BLACK

NO 번호	DATE 변경일자	DESCRIPTION OF REVISION 변경 내용	DESIGNED 작성	CHECKED 검토	APPROVED 승인	MATERIAL 재질		SPECIFICATION 규격		FINISH 표면처리	QUANTITY 수량	SCALE 척도 UNIT 단위	
						DESIGNED 작성	CHECKED 검토	APPROVAL 승인	DRAWING NUMBER 도 번호			mm	
			김도현	박재규	최국호								
DESIGNED 작성						상현전자 주식회사		3RD ANGLE PROJ	HANYONES TECH CO.,LTD	FILE. NO.			

